

Type 1311-A | AUDIO
OSCILLATOR

and

Type 1311-AU | AUDIOMETRIC
OSCILLATOR

G E N E R A L R A D I O C O M P A N Y

D

INSTRUCTION MANUAL

Type 1311-A | AUDIO OSCILLATOR

and

Type 1311-AU | AUDIOMETRIC OSCILLATOR

TABLE OF CONTENTS

Section 1 INTRODUCTION	4	Section 4 PRINCIPLES OF OPERATION	13
1.1 Purpose	4	4.1 General	13
1.2 Description	4	4.2 Circuit Description	13
Section 2 INSTALLATION	7	Section 5 SERVICE AND MAINTENANCE	16
2.1 General	7	5.1 Warranty	16
2.2 Rack Mounting	7	5.2 Service	16
2.3 Power Input	9	5.3 Minimum Performance Standards	16
2.4 Output Frequency Change	9	5.4 Input Power	16
2.5 Environmental Considerations	9	5.5 Removal of Cover	18
Section 3 OPERATING PROCEDURE	10	5.6 Trouble Analysis	18
3.1 Preparation of Use	10	5.7 Removal and Replacement	19
3.2 Operating Procedure	10	5.8 Internal Adjustments	20
		5.9 AC Power Conversion	20

Form No. 1311-0100-D

March, 1967

Copyright 1963 by General Radio Company
West Concord, Massachusetts, USA

GENERAL RADIO COMPANY
WEST CONCORD, MASSACHUSETTS, USA

SPECIFICATIONS

FREQUENCY

Range: Type 1311-A - 11 fixed frequencies from 50 to 10,000 Hz.

Type 1311-AU - 12 fixed frequencies from 125 to 8,000 Hz.

Control: Type 1311-A - 50, 60, 100, 120, 200, 400, 500, 1000, 2000, 5000, 10,000 Hz selected by rotary switch. A vernier provides a $\pm 2\%$ adjustment about nominal.

Type 1311-AU - 125, 250, 400, 500, 750, 1000, 1500, 2000, 3000, 4000, 6000, 8000 Hz selected by rotary switch. A vernier provides a $\pm 2\%$ adjustment about nominal.

Accuracy: $\pm 1\%$, vernier at 0.

OUTPUT

Power: 1w into matched load. (Taps provide at least 0.5w output into any resistive load between $80m\Omega$ and 8 k).

Voltage: Continuously adjustable from 0 to 1, 3, 10, 30, or 100, open circuit.

Current: Continuously adjustable from 0 to 40, 130, 400, 1300, 4000 ma, short circuit (approx).

Impedance: Between one and two times matched load, depending on control setting. Isolated from ground; hence, can be used to drive balanced circuits.

Stability (Typical after warmup): Amplitude, long term, better than 1%; short term, better than 0.01%. Frequency, long term, better than 0.1%.

DISTORTION AND NOISE LEVEL

Distortion: Less than 0.5% under any load condition. Typically less than 0.1% over most of range. Oscillator will drive short circuit without waveform clipping.

AC Hum: Typically less than 0.003% of output voltage.

GENERAL

Synchronization: A locking voltage from an external reference frequency can be introduced at a telephone jack. Locking range is approximately $\pm 3\%$ for 1-volt reference signal.

Terminals: Jack-top Type 938 Binding Posts with standard $\frac{1}{4}$ -inch spacing. Separate ground terminals holds Type 938-L Shorting Link which can be used to ground adjacent OUTPUT binding posts.

Power Input: 105 to 125 (or 210 to 250) v, 50 to 400 Hz. Total power consumption varies between 7 and 22 watts, depending on load.

Mounting: Aluminum panel and cabinet, in grey-crackle finish, for rack or bench use.

Accessories Supplied: Type CAP-22 Power Cord, spare fuses.

Accessories Available: Type 480-P308 Adaptor Plate Set to permit mounting in standard 19-inch relay rack (Panel height $5\frac{1}{4}$ inches).

Dimensions: Width 8, height 6, depth $7\frac{1}{4}$ inches (205 by 155 by 200 mm) over-all.

Net Weight: 6 pounds (2.8 kg).

U.S. Patent No. 2,751,549

For a more complete description, see *GENERAL RADIO EXPERIMENTER*, 36, 8 and 9, August-September, 1962.

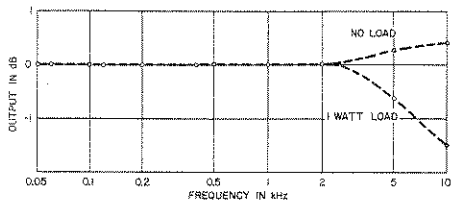

Figure A. Output of Type 1311 as a function of frequency, load and unloaded (typical).

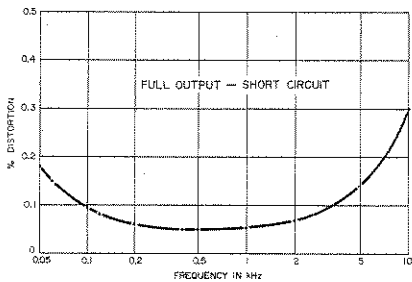
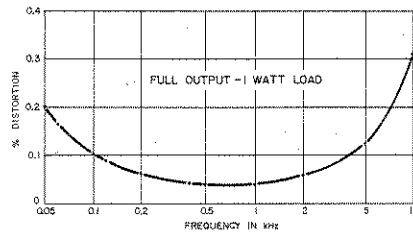
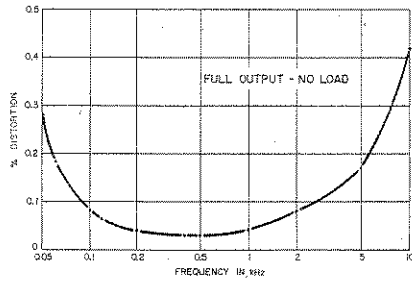

Figure B. Distortion characteristics of Type 1311 as functions of frequency and load (typical).

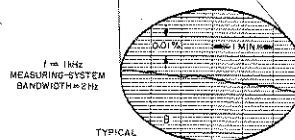
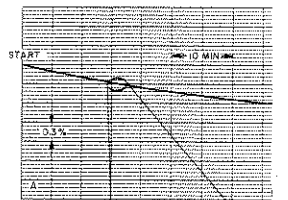

Figure C. Typical output amplitude stability of the oscillator, showing warmup drift (A) and short-term variation (B).

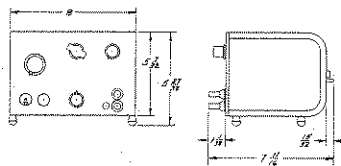

Figure D. Dimensions of the Type 1311.



SECTION 1

INTRODUCTION

1.1 PURPOSE.

1.1.1 GENERAL. The Type 1311 oscillators are complete, compact, and self-contained audio-frequency sources. The Type 1311-A (Figure 1-1) is intended for general laboratory use, and is particularly well suited for use in audio-frequency bridge measurements. Each oscillator produces an essentially pure sinusoidal output, stable in amplitude and frequency, over a wide range of load impedances, at selected frequencies. The Type 1311-A has eleven fixed frequencies and provision for a twelfth, which the user can readily add by installing two precision resistors.

1.1.2 THE TYPE 1311-AU AUDIOMETRIC OSCILLATOR. The Type 1311-AU is primarily intended to be used for calibration and testing of audiometric equipment. It will be especially useful for calibration of audiometric earphones, in conjunction with the Types 1551 and 1565 Sound Level Meters, (or the Type 1564 Sound and Vibration Analyzer), The Type 1560-P5 or -P6 (or the Type 1560-P3 or -P4) Piezoelectric Ceramic Microphone, and the Type 1560-P82 (or -P81) Earphone Coupler. The frequencies available from the Type 1311-AU include all those commonly used as audiometric test frequencies. The difference in output frequencies is the only characteristic in which the Type 1311-AU is unlike the Type 1311-A, and all instructions and descriptions supplied for the Type 1311-A are applicable to the Type 1311-AU unless specifically stated otherwise.

1.2 DESCRIPTION.

1.2.1 GENERAL. The Type 1311 is a transistorized RC Oscillator, which makes extensive use of negative feedback to attain amplitude and frequency stability of a high order, as well as long-term reliability. The

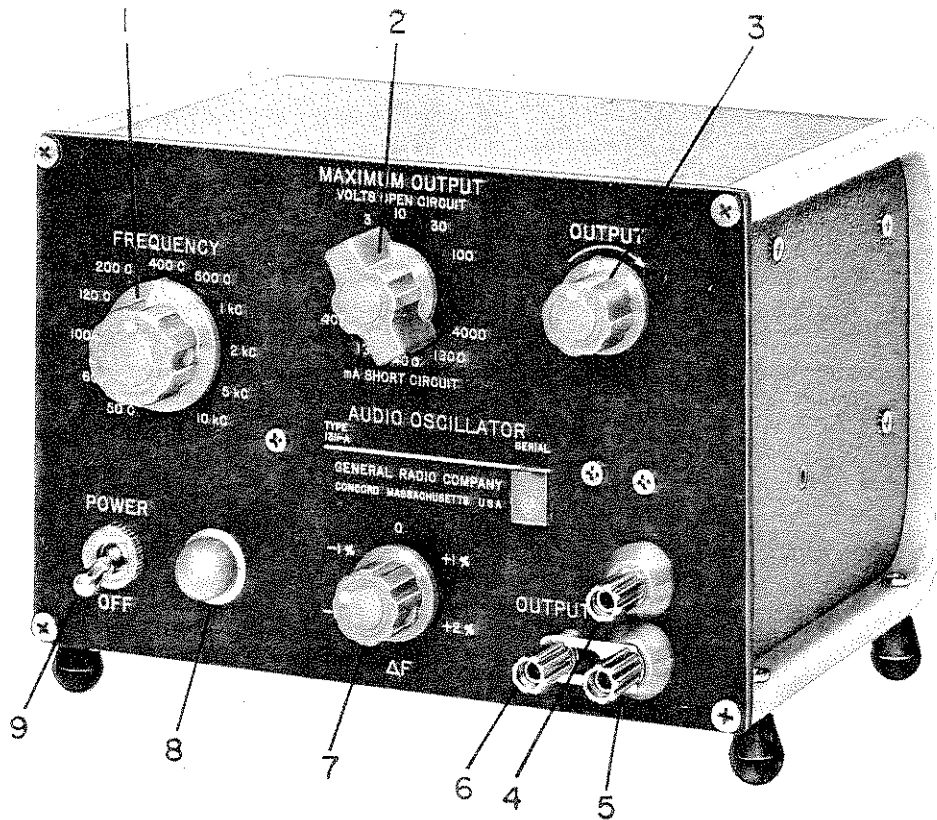

Figure 1-1. Type 1311-A Audio Oscillator.

output system uses a multitap shielded transformer capable of matching impedances from 0.25 to 2500 ohms. It is well isolated from the oscillator circuitry to provide a distortion-free waveform to any impedance, including a short circuit.

The instrument is ac powered and uses a regulated solid-state power-supply circuit to provide stable dc to all stages over a wide range of power demands. Operation at ac inputs of 115 or 230 volts can be achieved by selection of appropriate taps on the input winding of the primary power transformer.

The Type 1311 is designed for bench use but can conveniently and inexpensively be altered for rack mounting by the addition of the General Radio Type 480-P308 Adaptor Plate Set (Catalog No.0480-9638).



1.2.2 CONTROLS. Front panel controls are listed and described in Table 1-1.

TABLE 1-1
CONTROLS AND INDICATORS

Ref (Fig. 1-1)	Ref Desig	Name	Type	Function
1	S101	FREQUENCY	12-position rotary switch	Selects output frequency.
2	S102	MAXIMUM OUTPUT	5-position rotary switch	Selects output transformer tap.
3	R139	OUTPUT	Linear potentiometer	Adjusts output level.
7	R138	ΔF	Linear potentiometer	Adjusts output frequency $\pm 2\%$ about nominal.
9	S501	POWER	Toggle switch	Turns instrument on or off.
8	P501	None	Light	Glowes when primary power on.

1.2.3 CONNECTORS. Connectors provided on the Type 1311 are listed and described in Table 1-2.

TABLE 1-2
CONNECTORS

Ref (Fig. 1-1)	Ref Desig	Name	Type	Function
4-6	J101 thru J103	OUTPUT	Jack-top binding posts (GR Type 938)	Output terminals and ground.
	PL501	None	3-prong plug (GR Type 109-A)	Power input terminal.
	J104	None	Telephone	External Sync input

SECTION 2

INSTALLATION

2.1 GENERAL.

The Type 1311-A Audio Oscillator, as supplied, is intended for independent bench use. However, it may be adapted to rack mounting, either independently or in combination with a similarly sized instrument, such as the General Radio Type 1232-A, -AP Tuned Amplifier and Null Detector. This assembly, Type 1240-A, -AP Bridge Oscillator-Detector is convenient for use with audio-frequency bridges and other null-balance devices.

2.2 RACK MOUNTING.

2.2.1 RACK CONVERTING THE TYPE 1311. The Type 1311 Oscillator can be rack-mounted by itself in a standard 19-inch relay rack by means of Relay Rack Adaptor Set, Catalog Number 0480-9638, or with another convertible-bench instrument by means of Relay Rack Adaptor Set, Catalog Number 0480-9636. To attach the adaptor sets, proceed as follows (see Figure 2-1):

- a. Remove the rubber feet, if necessary to clear an instrument below.
- b. Remove the screws that secure the front panel to the aluminum end frames.
- c. Remove the spacers between the front panel and the end frames. If two instruments are to be mounted side by side, join them as follows: (otherwise proceed to step f):
- d. On one instrument, install clips with the front-panel screws removed earlier. Remove the cover of this instrument and thread the nylon screw through the hole in the side panel on the same side as the clips.

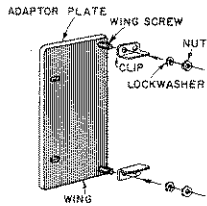

Figure 2-1a. Rack adapting the Type 1311.

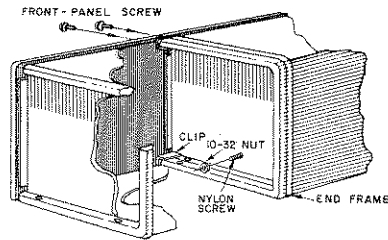

Figure 2-1b. The Type 1240.

e. Secure the two instruments together with front-panel screws through the remaining hole in each clip. Remove the cover of the second instrument, thread the nut onto the nylon screw, and tighten. Note that the instruments can be bench-mounted side by side in this manner. Simply do not remove the two feet from each outside end frame and do not install the adaptor plates..

f. Install two clips on each adaptor plate with the wing screws, lockwashers, and nuts supplied.

g. Attach the adaptor plates to the instrument with the front-panel screws removed earlier.

h. Mount the assembly in the rack with the 10-32 screws supplied.

2.2.2 MOUNTING THE TYPE 1620-A, -AP. The Type 1311 Oscillator is an integral part of the Type 1620-A, -AP Capacitance-Measuring Assembly. To assemble the Type 1620-AP follow the instructions in the instruction sheet supplied with the Type 1232-P2 Preamplifier. Then assemble the Type 1620-A, proceed as follows (see Figure 2-2):

a. Follow steps a through e in paragraph 2.2.1.

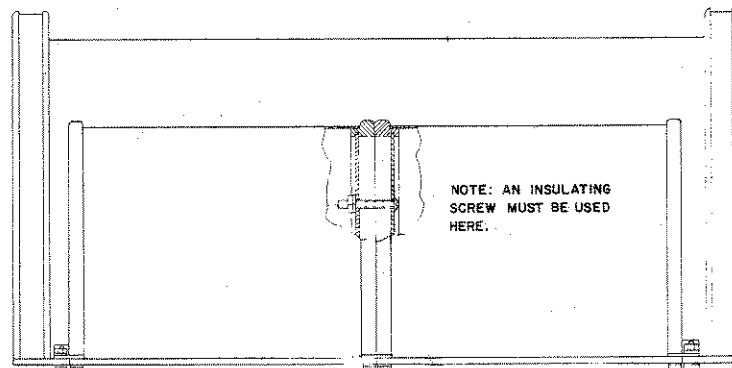

Figure 2-2. The Type 1620, top view.

b. Insert the "ears" of the mounting plates included in the Type 1620-A hardware set in the spaces between the front panels and the end frames of the Type 1311 and Type 1232.

c. Replace all remaining front panel screws.

d. Insert panel screws (those with the black cup washers) through the holes of the rack adaptor panels and through the mounting plates into the U-shaped end frames supplied with the Type 1620-A hardware set.

e. Stack mount the assembled instruments with the Type 1615 according to the instructions in the Type 1615 instruction manual.

2.3 POWER INPUT.

2.3.1 NORMAL OPERATION. The Type CAP-22 Three-Wire Power Cord (catalog number 4200-9622) supplied should be attached to PL501 on the rear panel and plugged into a standard grounding-type power receptacle providing 105-125 volts at 50 to 400 Hz.

2.3.2 HIGHER VOLTAGE. The instrument may be operated at ac inputs from 210 to 250 volts, provided that minor wiring and fuse changes described in Section 5 have been performed.

2.4 OUTPUT FREQUENCY CHANGE.

To add a 12th audio output frequency (Type 1311-A only), or to change any of the existing fixed frequencies, resistor pairs in the Wein-bridge circuit may be installed, or replaced, as described in Section 5.

2.5 ENVIRONMENTAL CONSIDERATIONS.

2.5.1 TEMPERATURE. The Type 1311 will operate within specifications over an ambient temperature range of 0 to 50 C. It is not affected by humidity.

2.5.2 EXTERNAL FIELDS. Since the Type 1311-A is often mounted with the sensitive Type 1232-A Null Detector, stray magnetic and electrostatic fields should be kept to a minimum by suitable shielding, and orientation of signal leads. A wire loop is included (internally) near the output terminals to cancel the magnetic field resulting from the 3/4-inch spacing of the output terminals, and will prevent magnetic pickup in the adjacent null detector, even at high current levels, if a General Radio Type 274-MB Shielded Output Cable is used. Alternatively, the Type 1311-A can be mounted at the right-hand side of the Type 1232-A, to place the output circuit as far as possible from the detector input terminals.



SECTION 3

OPERATING PROCEDURE

3.1 PREPARATION FOR USE.

3.1.1 POWER CONNECTIONS. Connect the Type 1311 to a suitable source of power as indicated on the plate above the power receptacle on the rear panel. A three-wire power cord (Type CAP-22) is supplied.

3.1.2 GROUNDING. The instrument should normally be operated with the chassis grounded through the three-wire power cord. If the cord is not used, make the ground connection at J103(6, Figure 1-1) on the front panel, if required.

3.1.3 OUTPUT CONNECTION. Take the oscillator output from the jack-top binding post pair J101 - J102 (4 and 5, Figure 1-1). J101 is always used above ground, but J102 may be grounded or ungrounded, depending on the requirements of the test setup in use. A captive shorting-link affixed to J103 may be attached to J102, if it is desired to work one side of the output against ground. However, if ground loops pose a problem, disconnect the shorting link from J102 to achieve a completely isolated "floating" output.

3.1.4 OUTPUT-SHIELDING ACCESSORIES. In applications in which stray pickup is apt to be troublesome, use of a shielded patch cord is suggested. The General Radio Type 274-NL Patch Cord, a polarized 3-foot shielded cable with a shielded double plug at each end, is available for this purpose.

3.2 OPERATING PROCEDURE.

3.2.1 TURN-ON. Place the POWER switch (9, Figure 1-1) in up position; the lamp immediately to the right should glow.

NOTE

No extensive warm-up time is required; a few seconds is sufficient.

3.2.2 FREQUENCY SELECTION. Set the FREQUENCY switch (1, Figure 1-1) to the desired frequency. Use the ΔF control (7, Figure 1-1) to adjust the selected frequency over a range of approximately $\pm 2\%$ of nominal. The frequency of the output waveform is within $\pm 1\%$ of the panel

engraving, with the ΔF control set at 0. For greater precision monitor the output with a frequency meter, such as the General Radio Type 1150 Digital Frequency Meter.

3.2.3 POWER SELECTION. Set the MAXIMUM OUTPUT switch (2, Figure 1-1) to a value in volts or milliamperes (as engraved on the front panel) that is slightly greater than the amplitude of the voltage or current desired. Then, rotate the OUTPUT control (3, Figure 1-1) to make the fine adjustment. The OUTPUT control sets the output at zero in its fully counterclockwise position, and rotated to its fully clockwise position provides a continuous linear increase up to the value of the MAXIMUM OUTPUT control setting.

The maximum power output is approximately 1.1 watt, so that bridges with 1-watt ratio arms, such as most General Radio bridges, cannot be damaged by overload. At least 0.58 watt of signal power can be supplied to any load between 80 milliohms and 8 kilohms, with the appropriate setting of the output switch. See Figure 3-1 for a plot of these values.

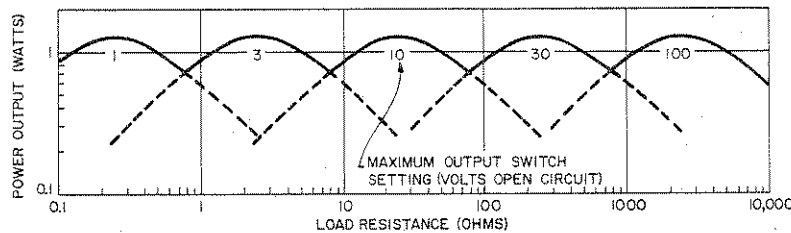

Figure 3-1. Typical power output as a function of load resistance.

3.2.4 IMPEDANCE MATCHING. Any setting of the output controls can be used with any load impedance without overloading the oscillator circuits. Even with a short circuit across the output terminals, the oscillator will still supply a sinusoidal current of the value indicated by the MAXIMUM OUTPUT control. This feature is particularly convenient when the oscillator is used as a source for ac bridge measurements, since it means that the output controls can be set to any position, and the waveform will not be distorted by mismatching.

The output winding is shielded from the oscillator circuits and may be used ungrounded, or grounded at a remote point. The latter procedure

is recommended when the oscillator is used in bridge measurements, to eliminate circulating ground currents, which can cause errors.

The nominal source resistance is a function of the transformer tap selected by the MAXIMUM OUTPUT control setting and the position of the OUTPUT control. Figure 3-2 shows the relationship.

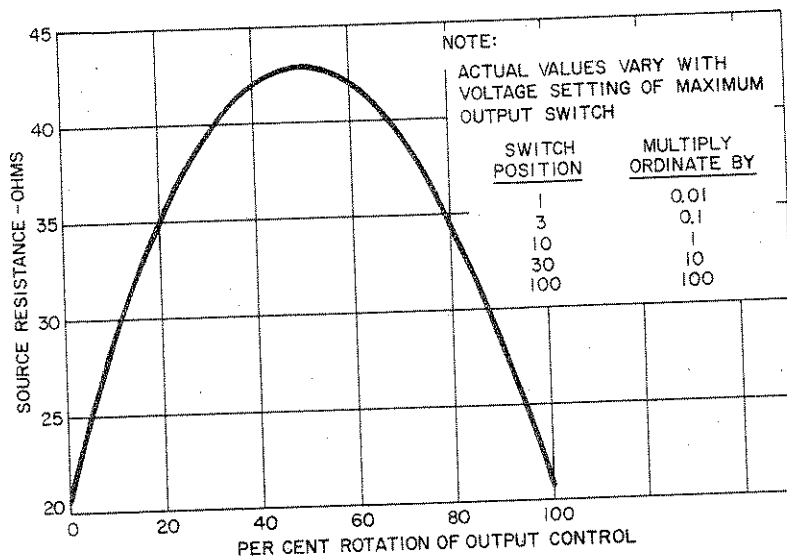

Figure 3-2. Source resistance as a function of output control settings.

3.2.5 FREQUENCY SYNCHRONIZATION. A telephone jack (J104) on the left side wall of the cabinet is provided to permit injection of an external standard frequency to control the output frequency of the Type 1311-A. This is particularly useful to drive the Type 1615-A Capacitance Bridge when making precise measurements of frequency-sensitive parameters such as dissipation factor. A 1-volt signal will result in a locking range of approximately $\pm 5\%$. For larger synchronizing signals, a resistor should be added in series with the signal lead. Use the following equation to calculate the value of the resistor required.

$$R \text{ (in kilohms)} \approx 5 (\text{Sync Volts} - 1)$$

The dc voltage on the reference signal should not exceed +50 volts. The General Radio Type 1115 Standard-Frequency Oscillator can be used with the addition of this resistor.

SECTION 4

PRINCIPLES OF OPERATION

4.1 GENERAL.

The Type 1311-A Audio Oscillator uses a Wien-type network and a closed-loop, transistor-amplifier circuit to obtain a stable yet inexpensive signal source which will satisfy many oscillator requirements in the audio-frequency spectrum. See Figure 4-1 for a simplified diagram and Figure 5-2 for the complete schematic.

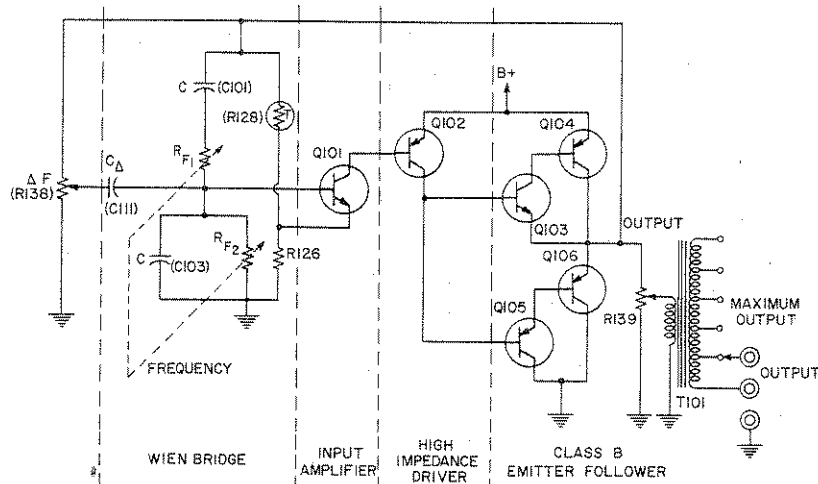

Figure 4-1. Simplified schematic diagram.

4.2 CIRCUIT DESCRIPTION.

4.2.1 FREQUENCY-DETERMINING NETWORK. The Wien-bridge circuit can be thought of as consisting of two parts: a frequency-determining network (C101, C103 and paired resistors R_{F1} , R_{F2}), which provides positive feedback to sustain oscillation, and a resistive divider (R128 and R126) which provides negative feedback to stabilize amplitude.*

* For a detailed discussion of this design feature, see Fulks, R. G., "Novel Feedback Loop Stabilizes Audio Oscillator," *ELECTRONICS*, Vol. 36 No. 5 February, 1963. Available as General Radio reprint A-107.

The frequency-determining network has a transfer function:

$$\frac{e_{OUT}}{e_{IN}} = \frac{RCs}{1 + 3RCs + R^2C^2s^2}$$

where $s = j2\pi f$
 $R = R_{F1} = R_{F2}$
 $C = C101 = C103$

At some oscillator frequency, f_0 , this function equals $+1/3$. The frequency is determined by any of 11 pairs of precision metal-film resistors, R_{F1} , R_{F2} , selected by the FREQUENCY switch. With this circuit, frequency can be adjusted over a 200-to-1 range simply by changes in resistors. The frequency vernier adjustment, ΔF , is potentiometer R138, which controls the signal voltage on C_{Δ} (C111), one of the capacitors in the network.

The resistive divider is used to set the gain of the associated amplifier chain to $+3$. The net loop gain is then $+1$ and the circuit oscillates at the frequency f_0 .

A small bead thermistor, R128, automatically adjusts its resistance to the value needed to maintain oscillations. Its time constant is short enough to provide rapid correction for amplitude variations, yet long enough to cause little distortion at the lower frequencies. It operates at a high temperature, in an evacuated bulb, to minimize the effects of ambient temperature. This thermistor, used with the high-stability, low-noise amplifier described below, results in an oscillator with amplitude (modulation) noise typically less than 0.01% rms.

4.2.2 AMPLIFIER. The amplifier uses six transistors in a single, direct-coupled feedback loop. The input circuit is chosen for low-noise performance. Transistor Q102 provides a high-impedance drive for the class-B output stage, and achieves a minimum of crossover distortion, yet does not require complicated, temperature-sensitive biasing networks. Negative feedback is used to obtain a transfer characteristic which is substantially independent of transistor characteristics, resulting in excellent stability, low distortion, and long-term reliability. Components R132, C107, and C108 comprise a phase-compensation network used to maintain high-frequency stability in view of the large amount of negative feedback involved.

The input impedance of the amplifier is approximately 10 megohms. The output impedance is approximately 0.005 ohm, so that changes in load have very little effect on the oscillator.

4.2.3 OUTPUT TRANSFORMER. The winding resistance of the output transformer, T101, isolates the oscillator from the load and ensures that the output waveform will not be clipped under any load condition. The output winding is tapped to provide five switch-selectable, output-voltage ranges to match a wide variety of load requirements. The output winding is doubly shielded from the oscillator circuits for isolation, when the output is used off ground (floating). A simplified schematic diagram of the output circuit is shown in Figure 4-2.

The second shield is used to minimize possible current flow through the distributed capacitance, C_{FL} ($\approx 500\text{pf}$), thence through an external circuit ground. The resulting floating potential, E_{FL} , of the output winding is less than 0.25 volt.

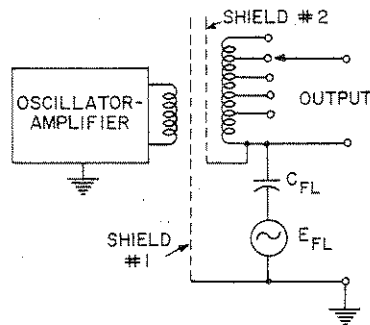

Figure 4-2. Simplified schematic diagram of output circuit.

4.2.4 POWER SUPPLY. Power transformer, T501, is used to apply 25.5 v ac to a silicon-diode bridge-rectifier and filter circuit. The filtered dc output passes through a simple regulator circuit, made up of Q501, Q502, and CR505, a zener diode. The supply provides a low-impedance, ripple-free, 20-v dc source to power the oscillator circuitry. The hum level of the oscillator output is typically 90 db below rated output signal value.

SECTION 5

SERVICE AND MAINTENANCE

5.1 WARRANTY.

We warrant that each new instrument sold and manufactured by us is free from defects in material and workmanship, and that, properly used, it will perform in full accordance with applicable specifications for a period of two years after original shipment. Any instrument or component that is found within the two-year period not to meet these standards after examination by our factory, Sales Engineering Office, or authorized repair agency personnel, will be repaired, or, at our option, replaced without charge, for tubes or batteries that have given normal service.

5.2 SERVICE.

The two-year warranty stated above attests the quality of materials and workmanship in our products. When difficulties do occur, our service engineers will assist in any way possible. If the difficulty cannot be eliminated by use of the following service instructions, please write or phone our Service Department (see rear cover), giving full information of the trouble, and of steps taken to remedy it. Be sure to mention the serial and type numbers of the instrument.

Before returning an instrument to General Radio for service, please write to our Service Department or nearest Sales Engineering Office, requesting a Returned Material Tag. Use of this tag will ensure proper handling and identification. For instruments not covered by the warranty, a purchase order should be forwarded to avoid unnecessary delay.

5.3 MINIMUM PERFORMANCE STANDARDS.

The Type 1311 in normal operation should perform within the standards described in Table 5-1. Table 5-2 lists the test equipment required to check minimum performance. If the instrument does not meet minimum performance standards, refer to paragraph 5.6 for trouble analysis procedures.

5.4 INPUT POWER.

The input power at 115/230 volts 60 Hz normally should not exceed 7 watts no load and 22 watts with the terminals short-circuited and the OUTPUT control fully clockwise.

TABLE 5-1
MINIMUM PERFORMANCE STANDARDS FOR TYPE 1311-A, -AU

TEST	FRE- QUENCY SWITCH POSITION	MAXIMUM OUTPUT SWITCH POSITION	OUTPUT CONTROL POSITION	Δf	LOAD	NORMAL INDICATION	IF INDICATION ABNORMAL
Frequency Accuracy	All	10 v	cw stop	0	None	Using frequency counter or meter, check that the frequency is within $\pm 1\%$ of nominal value.	Refer to para 5.6.
Δf Control	1 kHz	10 v	cw stop	-2%, 0, +2%	None	Using frequency counter or meter, check that frequency change is approximately plus and minus 2%.	Refer to para 5.6.
Output Voltage	1 kHz	All	cw stop	0	None	Using VTVM, check that output voltage is greater than that indicated by MAXIMUM OUTPUT Control.	Adjust by means of R129 (para 5.8.1).
Output Voltage	All	10 v	cw stop	0	None	Using VTVM, check that output voltage is greater than 10 volts.	Adjust by means of R129 (para 5.8.1).
OUTPUT Control	1 kHz	10 v		0	None	Using VTVM, check that output voltage can be adjusted by OUTPUT Control from 0 to 10 v.	Refer to para 5.6.
Output Power	1 kHz	10 v	cw stop	0	Power Output Meter	Using Power Output Meter, check that output power is greater than 1.0 watt into some impedance near 25 Ω .	Adjust by means of R129 (para 5.8.1).
Output Distor- tion	50 Hz* 1 kHz 10 kHz	10 v	cw stop	0	(None) (25 Ω) (1 Ω)	Using Distortion Meter, check that distortion is less than 0.5%.	Refer to para 5.6.
Synchro- nization	1 kHz	10 v	cw stop	0	None	Apply 1-v, 1-kHz signal to J104. With oscilloscope at OUTPUT, vary ext.-oscillator freq. Type 1311 should remain locked over a 5% range (approx)	Refer to para 5.6.

*125Hz for the Type 1311-AU.



**TABLE 5-2
TEST EQUIPMENT REQUIRED**

Description	Recommended GR Type Numbers*
Frequency Counter or Meter	1150-A, 1151-A, 1153-A, 1153-A,
Vacuum Tube Voltmeter	1806-A
Distortion and Noise Meter or Wave Analyzer	1932-A, or 1900-A
Output-Power Meter	1840-A
Variable-Frequency Audio Oscillator	1304-B, 1310-A
Oscilloscope	Laboratory quality, min bandwidth 1 kHz, min vert sensitivity 5 v/cm
Multimeter	Sensitivity 20,000 ohms/v

*Or equivalent

5.5 REMOVAL OF COVER.

To remove the cover, loosen the two captive thumb screws on the rear of the case and pull straight back.

5.6 TROUBLE ANALYSIS.

Perform the following procedures to isolate defects causing instrument malfunction as indicated by paragraphs 5.3 and 5.4. See Figures 5-1 through 5-5 for circuit function and part location.

- a. Disconnect primary power and remove cover.
- b. Check fuses F501 and F502; replace if defective.
- c. Visually check detail parts inside instrument for obvious defects, such as broken leads or charred surfaces. Repair or replace, as necessary.
- d. Reapply primary power and, with multimeter, check for 25 v ac across anchor terminals AT501 and AT502.

CAUTION

Semiconductor elements can be damaged by transients resulting from the insertion of instrument probes. Always turn off the power before connecting any test equipment to other than the output terminals. Restore power when connection is made.

- e. Switch multimeter to dc scale and check voltages as indicated on Figure 5-2. For accessibility of test points on etched-circuit board, see Figure 5-5.

NOTE

Complete circuit is enclosed in a single dc feedback loop, so that failure of one component will probably cause all voltages to differ considerably from the values shown.

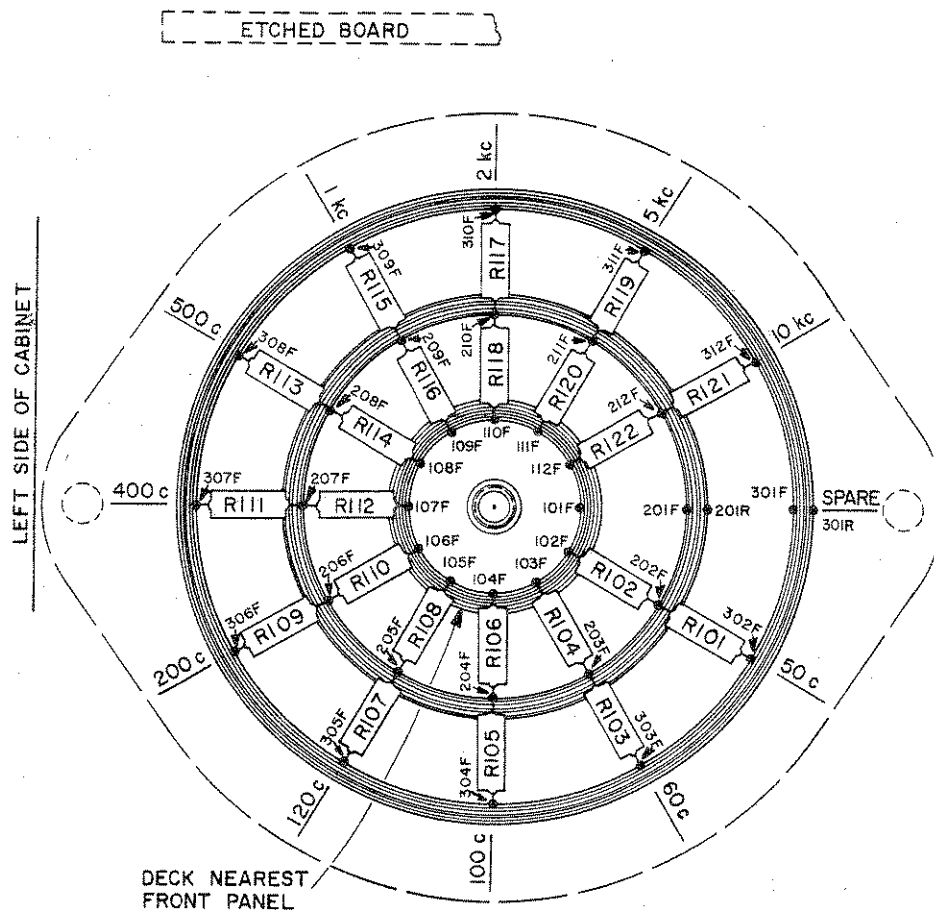

Figure 5-1a. Wiring diagram for FREQUENCY switch S101 on the Type 1311-A.

5.7 REMOVAL AND REPLACEMENT.

5.7.1 GENERAL. Faulty parts should be removed and replaced by units meeting the description given in the Parts List at the end of this section.

5.7.2 SEMICONDUCTORS. Since the expected life of the semiconductor elements in the Type 1311 is comparable to that of other components, they are soldered into the circuit boards. As a general rule, it is much safer to determine the faulty semiconductors from over-all circuit test, rather than to remove them individually for testing.

CAUTION

Transistors are easily damaged by excessive heat; exercise care when unsoldering them.

5.7.3 PILOT LIGHT. The pilot light (P501) is operated well below its rated voltage. If a change is required, unscrew the red cap from the front of the panel and replace the light with a Mazda # 44.

5.8 INTERNAL ADJUSTMENTS. (See Figures 5-2 through 5-5.)

5.8.1 OSCILLATOR LEVEL. R129, a secondary control used to adjust oscillator power level, is a screw-driver-adjustable potentiometer mounted on the underside of the etched circuit at its inside edge. With the dust cover removed, it is accessible from the bottom of the instrument.

R129 should be set so that the no-load output voltage, as indicated by a VTVM across the OUTPUT terminals, is approximately 5% higher than the value indicated by the MAXIMUM OUTPUT switch, when the OUTPUT control is turned fully clockwise.

5.8.2 OSCILLATOR FREQUENCY. Any frequency between 50 hertz and 10 kHz can be added to those provided on the Type 1311-A, by the installation of two precision resistors, R_F , whose values can be determined from the following relation:

$$R_F = 1.61 \times 10^3 \frac{(1 \text{ kHz})}{(f_{\text{kHz}})}$$

To utilize the twelfth position of the FREQUENCY selector switch, first calculate the value of the resistors required. For example, if a 600-Hz output is wanted, then

$$R_F = 1.61 \times 10^3 \frac{(1000)}{(0.6)} = 2.66 \text{ kilohms.}$$

The resistors must be mounted on the FREQUENCY switch (S101). An unused position (between the 50-Hz and 10-kHz positions) is provided for this purpose. Before installing the resistors on S101, remove the jumper between contacts 101F and 201F. The contacts 101F, 201F, and 301F may be reached from the bottom of the instrument. See Figure 5-1a for switch details. All twelve switch positions are used on the Type 1311-AU. These are shown in Figure 5-1b.

5.9 AC POWER CONVERSION.

5.9.1 GENERAL. The Type 1311 is available from the factory wired either for use with inputs of 105 to 125 or 210 to 250, 50 to 400 Hz. However, if the user wishes to convert the instrument from one power option

to the other, it is necessary merely to change wiring to the power-transformer input winding from power switch S501 and replace fuses.

WARNING

Pull the power cord from the receptacle before performing the following procedures.

5.9.2 TRANSFORMER WIRING. Remove the dust cover and place the instrument upside down on the bench. The input transformer (T501) is mounted on the side wall.

For 115-volt operation, transformer leads 1 and 3 should connect to lug 5 on S501 and leads 2 and 4 to lug 6 on S501. For 230-volt operation, lead 1 connects to lug 5, lead 4 to lug 6, and leads 2 and 3 are joined at anchor terminal AT506.

5.9.3 FUSES. Two fuses (F501 and F502), mounted on the inside of the vertical panel at the top rear, protect the instrument from electrical overload. They are accessible from the bottom, also. For 115 v, use 0.25-amp fuses; and for 230 v, use 0.125-amp fuses.

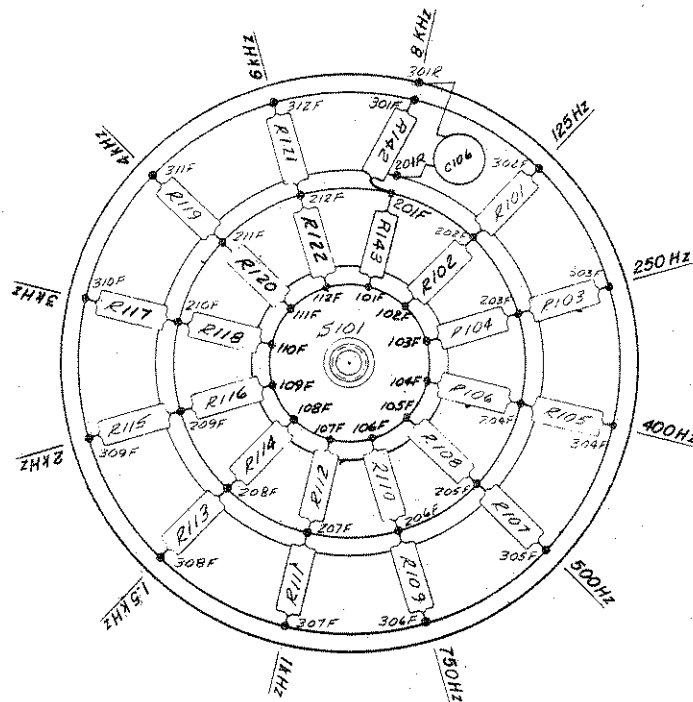

Figure 5-1b. Wiring diagram for FREQUENCY switch S101 on the Type 1311-AU.

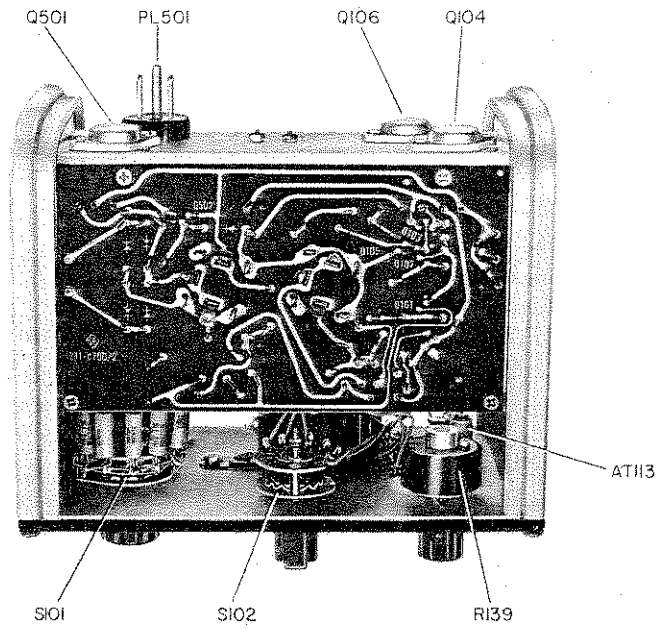

Figure 5-3. Top rear interior view.

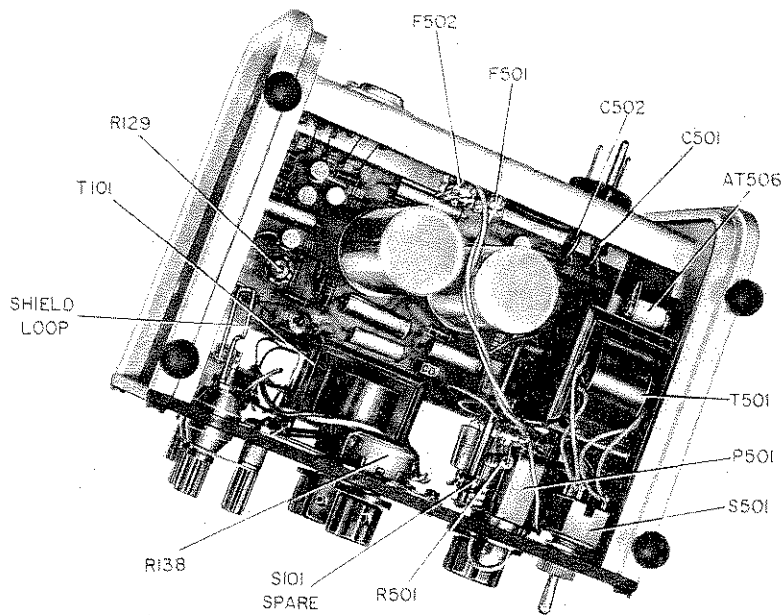
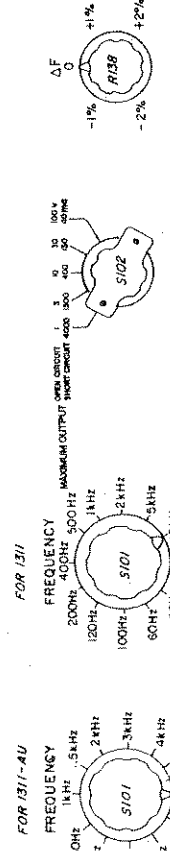

Figure 5-4. Bottom rear interior view.

NOTE: RESISTORS 1/2 WATT UNLESS OTHERWISE SPECIFIED
RESISTORS IN OHMS UNLESS OTHERWISE SPECIFIED
* 1 MEGOHM $\times 1000$ OHMS
CAPACITANCE VALUES: ONE AND OVER IN MICROFARADS
LESS THAN ONE IN MICROFARADS
UNLESS OTHERWISE SPECIFIED
* NOT USED IN SOME INSTRUMENTS
⊙ SCREWDRIVER ADJUSTMENT
○ KNOB CONTROL



Rotary switch sections are shown as viewed from the panel end of the shaft. The first digit of the contact number refers to the section. The section nearest the panel is 1, the next section back is 2, etc. The first two digits refer to the contact. Contact 01 is usually the screw above the locating key, and the other contacts are numbered clockwise from a strut screw (usually the screw above the locating key), and the other contacts are numbered sequentially (02, 03, 04, etc), preceding clockwise around the section. A suffix F or R indicates that the contact is on the front or rear of the section, respectively.

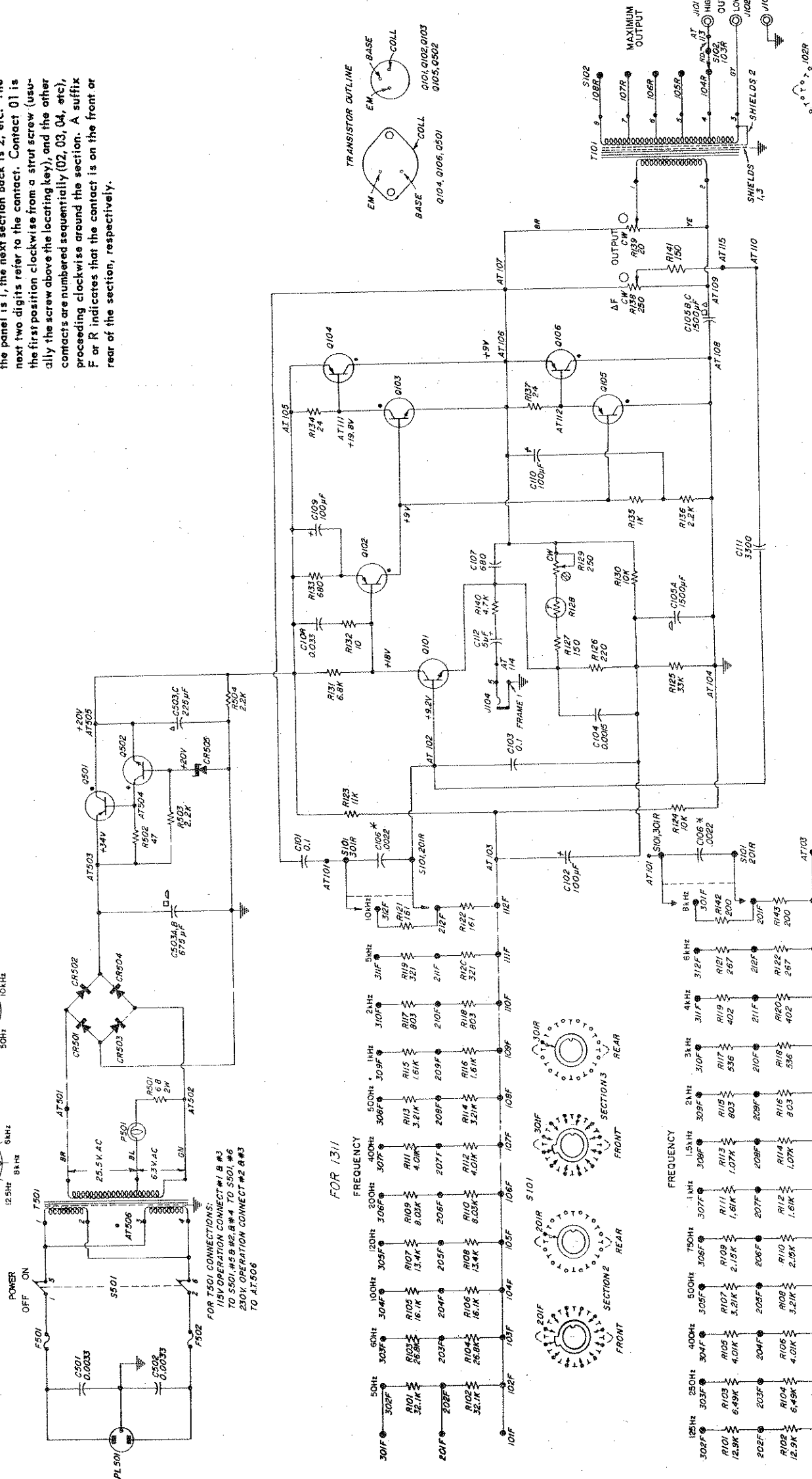

Figure 5-2. Schematic Diagram.

PARTS LIST

REF NO	PART NO	DESCRIPTION	PART NO	DESCRIPTION	PART NO
CAPACITORS					
C101	4860-8249	Plastic, 0.1µF ±1% 100 V	R120	Film, 402 Ω ±1% 1/2 W	6450-0402
C102	4450-2800	Electrolytic, 100µF 15 V	R121	Film, 267 Ω ±1% 1/2 W	6450-0267
C103	4860-8249	Plastic, 0.1µF ±1% 100 V	R122	Film, 267 Ω ±1% 1/2 W	6450-0267
C104	4406-2158	Ceramic, 0.0015µF ±10% 500 V	R142	Film, 200 Ω ±1% 1/2 W	6450-0200
C105A	4450-0700	Electrolytic, 1500µF 15 V	**R143	Film, 200 Ω ±1% 1/2 W	6450-0200
C105B,C	4450-0700	Electrolytic, 1500µF 25 V	R123	Composition, 11 kΩ ±5% 1/2 W	6100-3115
C106	4406-2228	Ceramic, 0.0022µF ±10%	R124	Composition, 10 kΩ ±5% 1/2 W	6100-3105
C107	4404-1689	Ceramic, 680pF ±20% 500 V	R125	Composition, 33 kΩ ±5% 1/2 W	6100-3335
C108	4860-7865	Plastic, 0.033µF ±10% 100 V	R126	Composition, 220 Ω ±5% 1/2 W	6100-1225
C109	4450-2800	Electrolytic, 100µF 15 V	R127	Composition, 150 Ω ±5% 1/2 W	6100-1155
C110	4450-2800	Electrolytic, 100µF 15 V	R128	Thermistor, 30 kΩ ±25%	6740-1402
C111	4570-1333	Mica, 3300pF ±10%	R129	Potentiometer, carbon, 250 Ω ±20%	6040-0200
C112	4406-2339	Electrolytic, 5µF ±100-10% 50 V	R130	Composition, 10 kΩ ±5% 1/2 W	6100-3105
C501	4406-2339	Ceramic, 0.0033µF ±20% 500 V	R131	Composition, 6.8 kΩ ±5% 1/2 W	6100-2685
C502	4450-4000	Ceramic, 0.0033µF ±20% 500 V	R132	Composition, 10 Ω ±5% 1/2 W	6100-0105
C503A		450µF 100 V	R133	Composition, 680 Ω ±5% 1/2 W	6100-1685
C503B		225µF 100 V	R134	Composition, 24 Ω ±5% 1/2 W	6100-0245
C503C		225µF 100 V	R135	Composition, 1 kΩ ±5% 1/2 W	6100-2105
			R136	Composition, 2.2 kΩ ±5% 1/2 W	6100-2225
			R137	Composition, 24 Ω ±5% 1/2 W	6100-0245
			R138	Potentiometer, Carbon, 250 Ω ±10%	6000-0100
			R139	Potentiometer, Wire-wound, 20 Ω ±5%	0971-3905
			R140	Composition, 4.7 kΩ ±5% 1/2 W	6100-2475
			R141	Composition, 150 Ω ±5% 1/2 W	6100-1155
			R501	Wire-wound, 6.8 Ω ±10% 2 W	6760-9689
			R502	Composition, 47 Ω ±5% 1/2 W	6100-0475
			R503	Composition, 2.2 kΩ ±5% 1/2 W	6100-2225
			R504	Composition, 2.2 kΩ ±5% 1/2 W	6100-2225
			MISCELLANEOUS		
			CR501	DIODE, 1N3253	6081-1001
			thru		
			CR504	DIODE, 1N969B, 22-V ±5% Zener	6083-1058
			CR505	FUSE, Slow-blow, 0.125 Amp (230V)	5330-0450
			F501	FUSE, Slow-blow, 0.125 Amp (230V)	5330-0450
			F502	FUSE, Slow-blow, 0.25 Amp (115V)	5330-0700
			F501	FUSE, Slow-blow, 0.25 Amp (115V)	5330-0700
			F502	FUSE, Slow-blow, 0.25 Amp (115V)	5330-0700
			J101	JACK, Binding post, insulated	0938-3000
			J102	JACK, Binding post, insulated	0938-3000
			J103	JACK, Binding post, insulated	0938-3022
			J104	JACK, Phone	4260-1230
			PL501	PLUG, Power	4240-0600
			P501	PILOT LIGHT, (Mazda #44)	5600-0700
			S101	SWITCH, Wafer	7890-3100
			S102	SWITCH, Wafer	7890-3110
			S501	SWITCH, Toggle	7910-1300
			T101	TRANSFORMER, Output	0745-4250
			T501	TRANSFORMER, Power	0745-4240
			Q101	TRANSISTOR, 2N1304	8210-1304
			Q102	TRANSISTOR, 2N1305	8210-1305
			Q103	TRANSISTOR, 2N1304	8210-1304
			Q104	TRANSISTOR, 2N176	8210-1760
			Q105	TRANSISTOR, 2N1305	8210-1305
			Q106	TRANSISTOR, 2N176	8210-1760
			Q501	TRANSISTOR, 2N1304	8210-1304
			Q502	TRANSISTOR, 2N176	8210-1760
				KNOB, AF Control	5530-0400
				KNOB, OUTPUT LEVEL Control	5530-0400
				KNOB, FREQUENCY Switch	5530-1200
				KNOB, OUTPUT Switch	5500-1700
				ETCHED-BOARD ASSEMBLY	1311-2701

*For Type 1311-A.
**For Type 1311-AU.



Figure 5-5. Etched circuit board.

NOTE: The number appearing on the foil side is not the part number.
The dot on the foil at the transistor socket indicates the collector lead.